

Heating & Air Conditioning **Amana**[®]

LASTS AND LASTS AND LASTS.[™]

PRODUCT SPECIFICATIONS



WITH
DIGISMART[™] CONTROL BOARD

Amana[®] brand Packaged Terminal Air Conditioners are the industry leader in factory-installed RF wireless Energy Management Systems.

The DigiSmart[™] control board has been standard on all Amana[®] brand PTACs since 2003 and can be retrofitted into all Amana[®] brand PTACs built since 1996.

The DigiSmart[™] control is a complete Energy Management System (EMS). So, your PTAC is ready to start reducing your energy costs by as much 35% from the moment you plug it in.



ARI Standard
310/380 PTAC
ARI (Air Conditioning & Refrigeration
Institute) Standards



Electrical Testing Laboratories



Canadian Standards Association
EEV Certification Programs

DIGISMART[™] PTAC

PACKAGED TERMINAL AIR CONDITIONERS AND HEAT PUMPS

The Amana[®] brand Packaged Terminal Air Conditioner is designed for customer comfort and owner piece of mind. No other PTAC in the industry offers so many energy management features as standard. And DigiSmart PTACs come with all the accessories you expect including seacoast coils, options for hydronic heat, and a full line of sleeves and grilles. Best of all the DigiSmart energy management system offers you the ability to reduce energy consumption by up to 35%.

With all this to offer, there is no need to settle for anything less than the Amana[®] brand DigiSmart[™] PTAC.

The Amana[®] brand PTAC is:

- Efficient with EER as high as 12.8 and heat pump COP as high as 3.6
- Able to fit any standard PTAC wall sleeve
- Easy to clean
- Easy to operate
- Fully tested in our factory

DigiSmart[™] has:

- A complete EMS software to manage PTAC performance
- Programmable temperature limits for both cooling and heating
- Programmable temperature set backs when PTAC is inactive
- Enhanced dehumidification
- Extensive unit diagnostics
- Backward compatibility for installation on all Amana[®] brand PTACs produced since 1996

When combined with the DigiSmart[™] Suite of Peripherals, Amana[®] brand PTACs add:

- Radio Frequency (RF) for wireless network communication
- Room occupancy sensors
- Central control through a PC interface
- E-mail maintenance messages
- An interface to property management and front-desk software packages

For more about DigiSmart[™], please see the next page. . .



PTAC WARRANTY

- **1ST YEAR — ALL PARTS & LABOR**
- **2ND THROUGH 5TH YEAR — SEALED SYSTEM: PARTS & LABOR**
- **OTHER COMPONENTS — PARTS ONLY**



DIGISMART™ SYSTEM

The Amana® DigiSmart™ suite of products work together to let you control and monitor each air conditioning unit.

IN-ROOM PRODUCTS

- A *PTAC* — The PTAC itself contains all the processing power and software to manage energy consumption, unit status, and comfort performance.
 - B *Occupancy Control* — The remote sensor above the door determines if the room is occupied or not. If occupied, normal routines run, but if unoccupied the PTAC can change temperature settings based upon configurations set by owner.
 - C *Remote Thermostat* — The DigiSmart™ remote thermostat works just like the one at home but unlike other PTACs does not disable the unit's own controls. Remote and PTAC control panels work at the same time and show the same information.
- *Set-up* — Best of all, no wiring. All of the peripheral devices can be installed by your handy man without calling an expensive electrician. A touch of a button connects the peripherals to the air conditioner in that room.

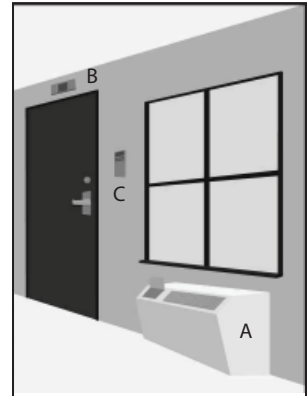

PROPERTY-WIDE NETWORK

- The Tridium Jace™ controller connects all Amana® DigiSmart™ PTACs in a property automatically through a self-detection routine.
- Once connected to your PC, the status and operating condition of each unit can be viewed remotely and its settings changed.
- The Tridium Jace™ controller through its NiagaraAX protocol has already built connections to more than 100 commercially available building management systems. So once the network is up and running, Amana® PTACs can be integrated with your existing building management system or if desired, controlled remotely through the internet.

For more information, go to www.amana-ptac.com.

PRODUCT FEATURES

On-Board Energy Management System (EMS)

- *Set-Back Mode* — the owner can determine amount of time unit is left 'untouched' (buttons not pushed) before the PTAC begins a set-back routine and new thermostat temperature takes effect. All set-back routines can be changed by owner.
- *Maintenance Status* — Separate green LED indicator light to show if unit requires maintenance
- *Electronic Temperature Limits* — owner can set separate cooling and heating temperature ranges and limit operation to one-degree increments, saving energy by preventing guests from over-cooling or over-heating.
- *Enhanced Dehumidification Cooling Mode* — the unit can be set to lengthen cooling cycles while the room is occupied or unoccupied. This passes more air through the unit while the coil is below the dew point, increasing the amount of moisture removed.
- *Unit Diagnostics* — when switched to diagnostics mode, the unit shows ten different self-diagnosis codes to help keep the unit running most efficiently.
- *Freeze Protection* — when sensors show an outdoor temperature of 40°F or below, the unit automatically activates the fan motor and the electric or hydronic heat to help prevent burst water pipes or broken fixtures caused by freezing temperatures.
- *Extended Heating with the Heat-Pump* — heat pump models will operate in heat-pump mode with external temperatures as low 24°F to provide additional energy savings.
- *30-Second Fan-Off Delay* — the fan continues to run for 30 seconds after the compressor has stopped or after electric heat has been turned off. This improves efficiency by dispersing the cooled or heated air still on the coil into the room.



AMANA® BRAND PTACs ARE:

- Energy Efficient: Amana® brand PTACs offer EER up to 12.8 and on heat pumps COP as high as 3.6
- Easy to Clean:
 - Inside the room, the removable pullout polymer filter is easy to clean and is ready for an optional activated charcoal filter to remove odors
 - Outside, the removable condenser shroud means easy access for coil cleaning, helping to maintain unit performance
- Easy to Use: one touch digital controls are simple and easy to use
- Maximize Room Space: slim 7 3/8" in-room depth and ability to install with zero floor
- Low Temperature Operation: heat pump operates as low as 24° and units come with "Freeze Protection" standard, running fan and heat when temperature dips below 40°
- Automatic Energy Heat: No more "No Heat" complaints in the middle of the night as heat pumps switch on electric heater if heating load greater than unit capacity.
- Full line of accessories including:
 - DigiSmart suite of Peripherals
 - Wireless Thermostat
 - Wireless Occupancy Sensor
 - Network Controller
 - Wall Sleeves in Stonewood (standard) or custom colors by order
 - Grilles in aluminum (stamped and extruded) or plastic in Stonewood (standard) or custom colors by order
 - Wired Thermostats
 - And many others...

DIGISMART™ SUITE OF PRODUCTS

Automatic Network Setup — the DigiSmart RF network automatically configures and heals itself. No need to log unit on or off the network.

High-Capacity Network — DigiSmart runs independently on each PTAC or up to **170** units in a single network installation

Set-Back Mode — the owner can determine amount of time unit is left 'untouched' (buttons not pushed) before the PTAC begins a set-back routine and new thermostat temperature takes effect. All set-back routines can be changed by owner.

Electronic Temperature Limits – owner can set separate cooling and heating temperature ranges and limit operation to one-degree increments, saving energy by preventing guests from over-cooling or over-heating.

Enhanced Dehumidification Cooling Mode—the unit can be set to lengthen cooling cycles while the room is occupied or unoccupied. This passes more air through the unit while the coil is below the dew point, increasing the amount of moisture removed.

Maintenance Status — Separate green LED indicator light to show if unit requires Maintenance at the unit level. Network interface shows status of each PTAC and peripheral (thermostat or sensor)

Unit Diagnostics — when switched to diagnostics mode, the unit shows ten different self-diagnosis codes to help keep the unit running most efficiently. Diagnostic codes captured at network level and

Email Notification — Once linked to a PC, the DigiSmart network can automatically send an e-mail to notify a property of maintenance issues.

Energy Management System (EMS) software — is written in 'flash' memory in the control board and not 'hard coded.' That means EMS software can be updated at the PTAC or through the DigiSmart network without needed to visit each unit.

AMANA® BRAND COMMITMENT TO QUALITY

We work to deliver the highest quality and best value PTAC in the USA. All Amana® brand PTACs are shipped from our factory in Fayetteville, TN, direct to our customers and distributors across the country. Our PTAC engineering design team is located right in our factory with the PTAC product line, meaning that we strive to deliver the best designed and manufactured PTAC in the marketplace.

Quality: All our PTACs are triple leak-tested before they leave the factory. We do this to ensure that when you get your PTAC, it is ready to go and trouble-free.

Cleaning: On the indoor side, our PTACs come with removable polymer filters for easy cleaning. The front of the PTAC opens up and the filters slide out. The polymer filters can be washed with water. Optional activated charcoal filters are available.

On the outdoor side, our PTACs have a removable condenser shroud cover, making cleaning the condenser coils easier. Remember: annual cleanings help keep your PTAC performing at its best.

EMS ACCESSORIES (@ [WWW.AMANA-PTAC.COM](http://www.amana-ptac.com))

DT01A — DIGITENNA: WIRELESS RF GATEWAY TRANSCEIVER ANTENNA

The DigiTenna mounts inside the Amana® brand DigiSmart PTAC, hidden from sight. It is powered through PTAC and requires no batteries. It is required for any of the DigiSuite RF wireless devices to communicate with the Amana® brand DigiSmart PTAC.

The DigiTenna communicates to any of the Amana DigiSmart suite of devices via an encrypted 2.4 Ghz signal using the 802.15 Zigbee standard. Some Amana® brand DigiSmart PTACs may require upgrades to the latest DigiSmart software to allow RF devices to be linked to the control.

For use with: DD01A and DS01B, both required parts of package

DS01B — DIGISTAT™ RF WIRELESS REMOTE-MOUNTED THERMOSTAT

The DigiStat is a remote wall-mounted thermostat that can control the Amana® brand DigiSmart™ PTAC from anywhere in the room. It is powered by 2 AAA batteries that are included in the kit.

The DigiStat communicates on a two-way RF encrypted signal. Settings can be changed either at the DigiStat or on the PTAC at the DigiSmart touch-pad. Both the PTAC and the thermostat show the same temperature information and communicate temperature information back and forth. So there no need to block off the unit controls as with a wired thermostat.

A DigiTenna (DT01A) is required for the DigiStat to communicate with the DigiSmart PTAC.

DD01A — DIGIDOOR: WIRELESS RF OCCUPANCY SENSOR

The DigiDoor is a combination door switch and room motion sensor powered by 2 AAA batteries that are included in the kit.

Once wirelessly linked to an Amana® brand DigiSmart™ PTAC, the DigiDoor monitors room occupancy and automatically activates the Energy Management System (EMS) temperature set-back function.

You can further refine your EMS programming by configuring the DigiSmart with up to 100,000 EMS set-back combinations, either through the DigiSmart touch-pad or wirelessly through the optional DigiTenna DT01A and DP01A Gateway.

The DigiTenna (DT01A) is required for the DigiDoor to communicate to the DigiSmart PTAC

DP01A — DIGIPLATFORM: WEB-ENABLED PLATFORM CONTROLLER

The DigiPlatform uses standard 115-volt power and communicates by antennae to each Amana® brand DigiSmart™ PTAC with a DigiTenna (DT01A) on an encrypted 2.4 GHz signal using the 802.15 Zigbee standard.

All DigiSmart™ suite of peripherals linked to a DigiSmart™ PTAC can be monitored, controlled, and upgraded easily through the DigiPlatform wireless RF network. Up to 170 PTACs in a single location can be networked through a single DigiPlatform depending on building layout and distance between PTACs.

Because it is Web-enabled, all DigiPlatform functions can be accessed through the Amana® brand Hotel Link software contained in the DigiPlatform.

The DigiPlatform has several other software applications embedded in the device that allow optional connectivity to a property management system to monitor room rental status. Optional drivers and/or software are required.

The DigiPlatform allows operational monitoring of each PTAC and peripheral device. Additional optional software may be required.

DSUK01B — DIGISMART CONTROL BOARD UPGRADE KIT

Any Amana® brand Series A or Series B PTAC produced since 1996 can be upgraded with a DigiSmart™ control board.

The DSUK01B is a field-installation kit to convert an older 'knob control' Amana® brand PTAC to the new DigiSmart™ LED control.

The converted Amana® brand PTAC has the same energy management system as a DigiSmart™ PTAC and can connect to the DigiSmart™ suite of peripheral devices.

REMOTE ENERGY MANAGEMENT SYSTEMS (EMS) READY

The DigiSmart control is also ready for wired applications.

An 18-pin low-voltage connector links the PTAC to many wired Energy Management Systems and wired thermostats. The unit's off-board 20-va transformer has enough power to supply energy to most commercially available thermostats. Also, the unit can be configured to be used with either a "B" or an "O" terminal, further increasing the types of thermostats that can be connected to the unit.

PTAC ACCESSORIES (MORE @ WWW.AMANA-PTAC.COM)

WALL SLEEVE 14 1/8" (D) x 42" (W) x 16 1/16" (H)

Our insulated, Stonewood Beige metal sleeves with industry-standard dimensions are shipped with a weather board for use during construction. The WS900D is an industry-standard depth of 14 1/8". The extra-deep sleeves can be custom ordered starting at 16" to 24" (D) in 1" increments. Sleeves may be shipped separately to allow for installation during construction.

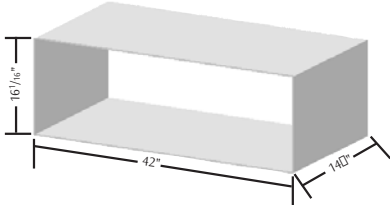

WS900D	Standard 14 1/8" Depth
WS9**D1	Extra Deep (16" to 24")

** Depth in inches

CONDENSATE DRAIN KIT

Attaches to the wall sleeve base pan for controlled internal or external disposal of condensate.

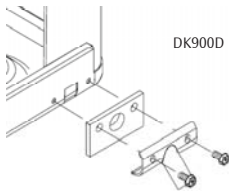

DK900D	Condensate Drain Kit (use with WS900D)
DK9001D	Condensate Drain Kit (use with WS900B & extra deep wall sleeves)

OUTDOOR GRILLES

Available in stamped aluminum or architecturally louvered for application with a WS900D wall sleeve.

AGK — Extruded aluminum architectural grille available with anodized aluminum finish and a baked-on paint finish for durability. Choose from three stock colors or a custom color.

PGK — One-piece injection molded grille using a polymer blend of engineered thermoplastic high-impact strength material with chemical resistance and an exterior UV protective coating. Choose from three stock colors.

Colors:
DB (Dark Brown/Bronze), TB (Stonewood Beige), WB (White), SB (Special/Custom Colors)

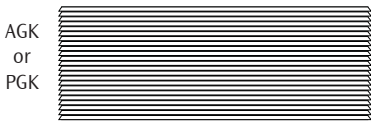
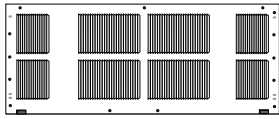

Standard Outdoor Grille	
SGK01B	Single Pack
Architectural Grille	
AGK01*B	Single Pack
PGK01*B	Single Pack

CONDENSER BAFFLE KIT

For use on non-baffled grilles. These deflectors direct the air in toward the center and away from the inlet to prevent recirculation of the hot condenser air.

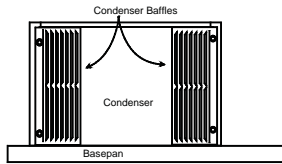

DGK1B	Condenser Baffle Kit
-------	----------------------

WIRE HARNESS KIT

For quick connections of the remote thermostat or front desk with jumpers and connectors.



PWHK01C	Wire Harness Kit
---------	------------------

STC 30 RATING ACCESSORY KIT

Raises sound ratings from 27 to 30 to meet or exceed most sound test requirements.

STC101A	10 Pack
---------	---------

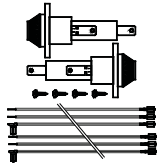
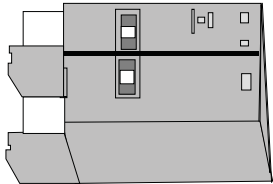
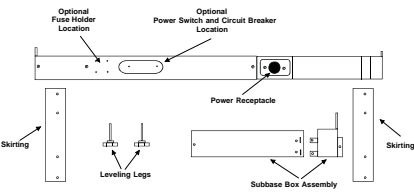
ACCESSORIES (CONT.)

<p align="center">SECURITY KEY LOCKS</p> <p>In conjunction with the tamper-resistant front, the installation of Amana® brand security key locks prevents tampering of the controls used to set temperature, heating and cooling functions. UL approved for institutional use only.</p> <table border="1" data-bbox="272 457 651 499"> <tr> <td>KL03B</td> <td>Security Key Lock</td> </tr> </table>	KL03B	Security Key Lock	<p align="center">SUB-BASE EXTENSION COVER KIT</p> <p>Converts older 30-amp sub-bases to allow for installation of the larger 30-amp LCDI power cord and plugs.</p> <table border="1" data-bbox="963 415 1318 457"> <tr> <td>SBEC10A</td> <td>10 Pack</td> </tr> </table>	SBEC10A	10 Pack																																																											
KL03B	Security Key Lock																																																															
SBEC10A	10 Pack																																																															
<p align="center">POWER VENT KIT (NOT SHOWN)</p> <p>Installation of Power Vent increases CFM up to approximately 95. Vent door will automatically close when unit fan is off.</p> <table border="1" data-bbox="289 646 667 709"> <tr> <td>PVK3A</td> <td>230/208V</td> </tr> <tr> <td>PVK4A</td> <td>265V</td> </tr> </table>	PVK3A	230/208V	PVK4A	265V	<p align="center">POWER DOOR KIT (NOT SHOWN)</p> <p>Vent door will automatically open when unit fan is on.</p> <table border="1" data-bbox="954 646 1333 709"> <tr> <td>PDK3A</td> <td>230/208V</td> </tr> <tr> <td>PDK4A</td> <td>265V</td> </tr> </table>	PDK3A	230/208V	PDK4A	265V																																																							
PVK3A	230/208V																																																															
PVK4A	265V																																																															
PDK3A	230/208V																																																															
PDK4A	265V																																																															
<p align="center">FUSE HOLDER KIT</p> <p>Cartridge-style fuses can be installed in the fuse holder for use in the sub-base or chassis. Available in 15, 20 and 30 amp (included on 265-volt unit).</p>  <table border="1" data-bbox="313 1066 639 1161"> <tr> <td>FHK315C</td> <td>230/208V</td> <td>15A</td> </tr> <tr> <td>FHK320C</td> <td>230/208V</td> <td>20A</td> </tr> <tr> <td>FHK330C</td> <td>230/208V</td> <td>30A</td> </tr> </table>	FHK315C	230/208V	15A	FHK320C	230/208V	20A	FHK330C	230/208V	30A	<p>• Circuit Breaker Kit (230/208V only)</p> <p>The circuit breaker kit, available in 15, 20 or 30 amp, can be used with Amana® brand sub-bases. It gives overcurrent protection, and its location allows you to turn the unit on or off without tools.</p>  <table border="1" data-bbox="963 1098 1318 1140"> <tr> <td>CBK3**C</td> <td>Circuit Breaker Kit</td> </tr> </table>	CBK3**C	Circuit Breaker Kit																																																				
FHK315C	230/208V	15A																																																														
FHK320C	230/208V	20A																																																														
FHK330C	230/208V	30A																																																														
CBK3**C	Circuit Breaker Kit																																																															
<p align="center">SUB-BASE KIT</p> <p>The fully skirted sub-base conceals wiring while providing strong support, if needed. Plug-in receptacle and field-wiring access speeds installation. Electrical accessories, such as fuse holders, circuit breakers and disconnect switches, meet N.E.C. requirements.</p>  <table border="1" data-bbox="297 1539 639 1707"> <tr> <td>PTSB320E</td> <td>230/208V</td> <td>15/20A</td> </tr> <tr> <td>PTSB330E</td> <td>230/208V</td> <td>30A</td> </tr> <tr> <td>PTSB420E</td> <td>265V</td> <td>15/20A</td> </tr> <tr> <td>PTSB430E</td> <td>265V</td> <td>25A</td> </tr> <tr> <td>PTSB000E</td> <td colspan="2">Non-electrical</td> </tr> </table>	PTSB320E	230/208V	15/20A	PTSB330E	230/208V	30A	PTSB420E	265V	15/20A	PTSB430E	265V	25A	PTSB000E	Non-electrical		<p align="center">THERMOSTATS</p> <p>The following thermostats offer remote control. Any thermostat other than those listed must be submitted to Goodman Company, L.P., for approval prior to use.</p>  <table border="1" data-bbox="824 1444 1466 1749"> <thead> <tr> <th>MODEL</th> <th>HEAT STAGES</th> <th>COOL STAGES</th> <th>DISPLAY</th> <th>TYPE</th> <th>SHAPE & ORIENTATION</th> </tr> </thead> <tbody> <tr> <td>C5200609</td> <td>1*</td> <td>1</td> <td>Mech.</td> <td>Manual</td> <td>Round</td> </tr> <tr> <td>D9945801</td> <td>2**</td> <td>1</td> <td>Mech.</td> <td>Manual</td> <td>Rect./Horiz.</td> </tr> <tr> <td>1246005/6</td> <td>1*</td> <td>1</td> <td>Mech.</td> <td>Manual</td> <td>Rect./V or H</td> </tr> <tr> <td>1246001</td> <td>1*</td> <td>1</td> <td>Digital</td> <td>Manual</td> <td>Rect./Horiz.</td> </tr> <tr> <td>1246003</td> <td>2**</td> <td>1</td> <td>Digital</td> <td>Manual</td> <td>Rect./Horiz.</td> </tr> <tr> <td>1246004</td> <td>2**</td> <td>1</td> <td>Digital</td> <td>Program</td> <td>Rect./Horiz.</td> </tr> <tr> <td>1241501</td> <td>2**</td> <td>1</td> <td>Digital</td> <td>Auto Change</td> <td>Rect./Vert.</td> </tr> </tbody> </table> <p>* PTC Models Only ** PTC and PTH Models</p>	MODEL	HEAT STAGES	COOL STAGES	DISPLAY	TYPE	SHAPE & ORIENTATION	C5200609	1*	1	Mech.	Manual	Round	D9945801	2**	1	Mech.	Manual	Rect./Horiz.	1246005/6	1*	1	Mech.	Manual	Rect./V or H	1246001	1*	1	Digital	Manual	Rect./Horiz.	1246003	2**	1	Digital	Manual	Rect./Horiz.	1246004	2**	1	Digital	Program	Rect./Horiz.	1241501	2**	1	Digital	Auto Change	Rect./Vert.
PTSB320E	230/208V	15/20A																																																														
PTSB330E	230/208V	30A																																																														
PTSB420E	265V	15/20A																																																														
PTSB430E	265V	25A																																																														
PTSB000E	Non-electrical																																																															
MODEL	HEAT STAGES	COOL STAGES	DISPLAY	TYPE	SHAPE & ORIENTATION																																																											
C5200609	1*	1	Mech.	Manual	Round																																																											
D9945801	2**	1	Mech.	Manual	Rect./Horiz.																																																											
1246005/6	1*	1	Mech.	Manual	Rect./V or H																																																											
1246001	1*	1	Digital	Manual	Rect./Horiz.																																																											
1246003	2**	1	Digital	Manual	Rect./Horiz.																																																											
1246004	2**	1	Digital	Program	Rect./Horiz.																																																											
1241501	2**	1	Digital	Auto Change	Rect./Vert.																																																											

ACCESSORIES (CONT.)

HARD-WIRE KIT (NOT SHOWN)

Used to permanently wire to the chassis when a standard sub-base and power cord are not utilized.

PTPWHWK4	Hard Wire Kit
----------	---------------

POWER DISCONNECT SWITCH (NOT SHOWN)

The PSHW**A power disconnect switch can be used for 265-volt or 230/208-volt physical disconnect, where required by local codes. The switch is rated at 30-amp capacity. The switch is for use with and Amana® brand standard sub-bases or PTPWHWK4 Hard Wire Kit.

PSHW03A	230/208V
PSHW04A	265V

CONDENSATE REMOVAL PUMP

Can be field installed. Assists in removing condensate developed by heat pump operation and transfers it to indoor coil to dissipate into room while adding humidity to the room.

CDP302	230/208V
CDP402	265V

SPARE FILTERS

Helps keep dirt and lint out of the air and off the coil, thus increasing the unit's efficiency. Amana® brand filters are easy to remove, wash and replace.

FK10A	Filters (10-pack) - A Series
FK10B	Filters (10-pack) - B Series

REPLACEMENT CHARCOAL FILTER KIT

Absorbs airborne odors caused by cigarette, pipe or cigar smoke and odors caused by mold, mildew, etc. Filters are made of polyester fibers coated with activated charcoal and are individually wrapped. This filters are permanent and can be washed or cleaned. Call your Amana® brand PTAC sales person for details. 10 filters per pack.

CFK10A	Charcoal Filters (10-pack) - A Series
CFK10B	Charcoal Filters (10-pack) - B Series

HEATER KIT—FOR HEATER-LESS UNITS ONLY

Optional 1.5 kW heater kits are available for use only with models originally shipped without electric heat. Ask salesperson for details.

	Model Nominal BTUs	230V	208V	265V
Rated Watts	All	1,500	1,200	1,500
Full Load Amps (incl. fan)	7K & 9K	6.9	6.2	6.1
	12K & 15K	7.1	6.4	6.3
Min. Ampacity	7K & 9K	8.6	8.6	7.5
	12K & 15K	8.8	8.8	7.7
Fuse Size	All	15	15	15

HYDRONIC HEAT KIT

Add-on kits fit all units allowing the addition of hydronic water or hydronic steam heat to cooling and heating units. The kits feature left- or right-hand piping. Unit retains complete service access with a kit installed. Unit must be connected to and operated by a wall thermostat.

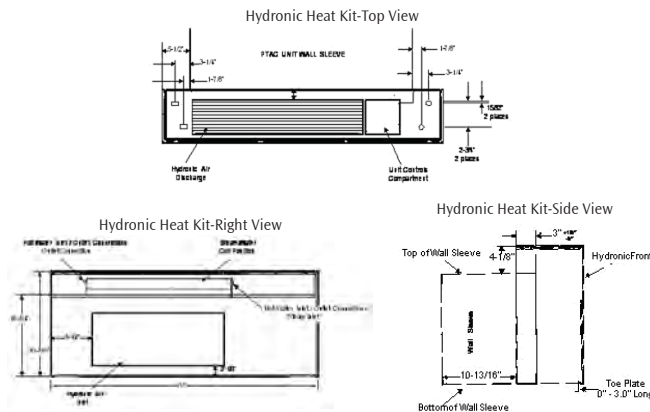

HWK03B	Hydronic Water Kit
HVK03B	Hydronic Steam Kit

DUCT EXTENSION KIT

Extends air distribution to an adjoining room. Consists of a main duct for the room of origin and an extension duct to reach the adjoining room and terminal duct. PTDK01A allows for the new "B" series unit to work with the "A" series duct kits.

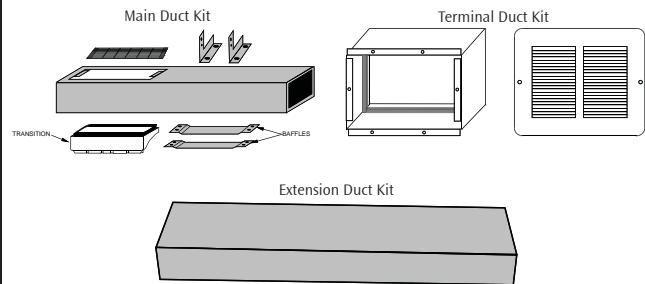

MDK02B	Main Duct
EDK02B	Extension Duct
TDK02	Terminal Duct
PTDK01A	Transition Duct Only

PRODUCT SPECIFICATIONS

ACCESSORIES (CONT.)

<p style="text-align: center;">HYDRONIC VALVES (NOT SHOWN)</p> <p>Water and steam valves are available for use with the HWK03 (water) and HVK03 (steam) heat kits. (See Architects and Engineers Manual for specifications.)</p> <table border="1" style="width: 100%; border-collapse: collapse; margin-top: 10px;"> <tr><td style="width: 20%;">VS2WNCA*</td><td>2-way/24V/NC/Steam</td></tr> <tr><td>VS2WNOA*</td><td>2-way/24V/NO/Steam</td></tr> <tr><td>VW2WNCA*</td><td>2-way/24V/NC/End Switch</td></tr> <tr><td>VW2WNOA*</td><td>2-way/24V/NO/End Switch</td></tr> <tr><td>VW3WNC2B*</td><td>3-way/24V/NC/NO/End Switch</td></tr> </table> <p style="font-size: small; margin-top: 5px;">* Pop-top Actuator</p>	VS2WNCA*	2-way/24V/NC/Steam	VS2WNOA*	2-way/24V/NO/Steam	VW2WNCA*	2-way/24V/NC/End Switch	VW2WNOA*	2-way/24V/NO/End Switch	VW3WNC2B*	3-way/24V/NC/NO/End Switch	<p style="text-align: center;">HYDRONIC TRANSFORMER RELAY KIT (NOT SHOWN)</p> <p>Add-on kit that allows field conversion of a standard PTC unit to a hydronic unit.</p> <table border="1" style="width: 100%; border-collapse: collapse; margin-top: 10px;"> <tr><td style="width: 20%;">HTK3A</td><td>230/208V</td></tr> <tr><td>HTK4A</td><td>265V</td></tr> </table> <p style="text-align: center; margin-top: 10px;">REMOTE ESCUTCHEON KIT (NOT SHOWN)</p> <p>Optional kit for use with units controlled via a wired, remote thermostat. Covers control touch-pad for wired thermostat installations.</p> <table border="1" style="width: 100%; border-collapse: collapse; margin-top: 10px;"> <tr><td style="width: 20%;">REK10B</td><td>Remote Escutcheon Kit (10-pack)</td></tr> </table> <p style="font-size: small; margin-top: 10px;">Each kit contains 80 wires and wire nuts, enough to attach a thermostat and one additional accessory to 10 PTAC units. Wires come in assorted colors for easy attachment.</p>	HTK3A	230/208V	HTK4A	265V	REK10B	Remote Escutcheon Kit (10-pack)
VS2WNCA*	2-way/24V/NC/Steam																
VS2WNOA*	2-way/24V/NO/Steam																
VW2WNCA*	2-way/24V/NC/End Switch																
VW2WNOA*	2-way/24V/NO/End Switch																
VW3WNC2B*	3-way/24V/NC/NO/End Switch																
HTK3A	230/208V																
HTK4A	265V																
REK10B	Remote Escutcheon Kit (10-pack)																

NOMENCLATURE

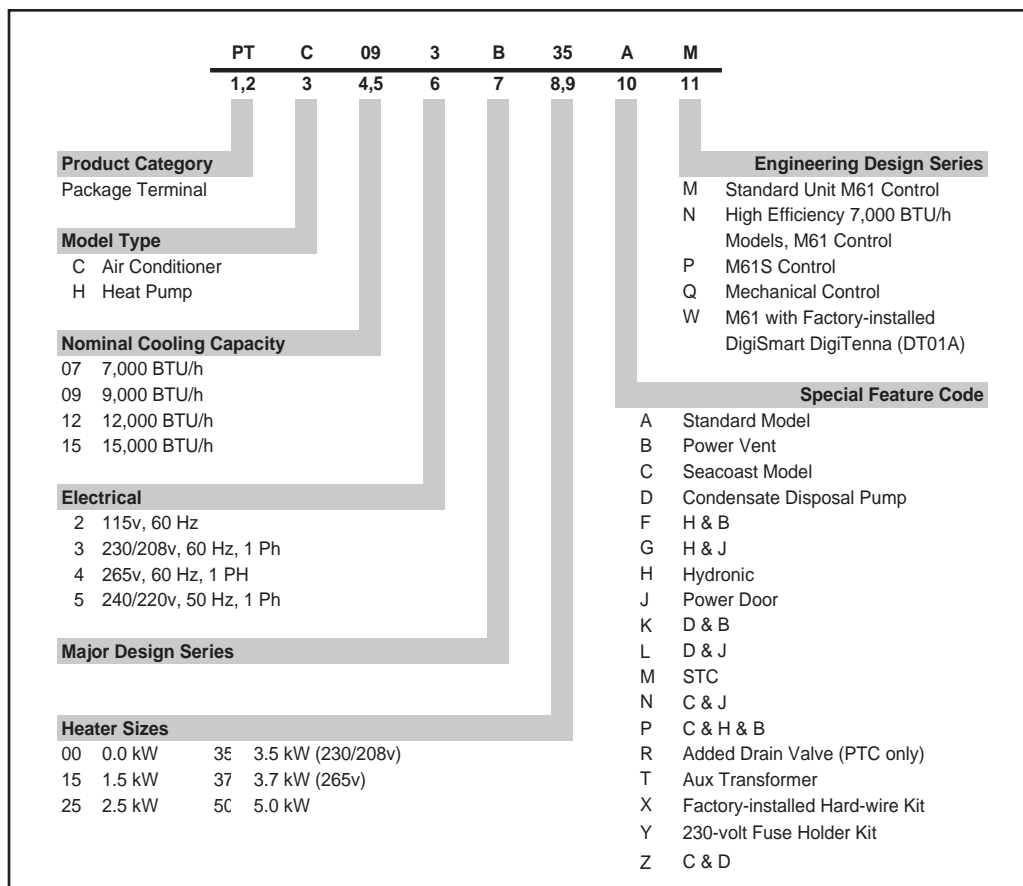

PRODUCT SPECIFICATIONS : PTC MODELS — COOLING/ELECTRIC HEAT

Model ^{1, 7, 9, 10, 12}		PTC 073B**A-	PTC 074B**A-	PTC 093B**AM	PTC 094B**AM	PTC 123B**AM
Voltage ^{1, 3, 11}		230 / 208	265	230 / 208	265	230 / 208
Capacity (BTU/h)	M Models	7,100 / 6,900	7,100	9,100 / 8,900	9,100	12,000 / 11,900
	N Models	7,400 / 7,300	7,300	N / A	N / A	N / A
Amps ¹²		2.8 / 3.0	2	3.7 / 3.8	3	4.6 / 5.0
Watts ¹²		610 / 595	610	790 / 775	790	1,110 / 1,100
EER	M Models	11.6 / 11.6	12	11.5	11.5	10.8
	N Models	12.4 / 12.8	12.4	N / A	N / A	N / A
UNIT WITHOUT ELECTRIC HEATER						
Min. Circuit Amps ^{2, 4, 12}		4	3.6	5.1	4.4	6.4
CFM (Cool/Wet Coil)	High	245 / 240	245	245 / 240	245	325 / 315
	Low	220 / 205	220	220 / 205	220	250 / 229
CFM (Dry Coil)	High	265 / 260	265	265 / 260	265	345 / 335
	Low	230 / 215	230	230 / 215	230	265 / 235
Ventilated Air, CFM (Fan Only)*		65*	65*	65*	65*	70*
Ventilated Air, CFM (Compressor & Fan)*		65*	65*	65*	65*	70*
Dehumidification (Pints/Hr.)		1.6	1.6	2.6	2.6	3.5
Net Weight (lbs.)		90	90	95	95	105
Ship Weight (lbs.)		105	105	110	110	120

Model ^{1, 7, 9, 10, 12}		PTC 124B**AM	PTC 123C**AM	PTC 124C**AM	PTC 153B**AM	PTC 154B**AM
Voltage ^{1, 3, 11}		265	230 / 208	265	230 / 208	265
Capacity (BTU/h)	M Models	12,000	11,700 / 11,600	11,600	14,000 / 13,900	14,000
	N Models	N / A	N / A	N / A	N / A	N / A
Amps ¹²		4.3	4.8 / 5.2	4.7	6.3 / 6.9	5.9
Watts ¹²		1,130	1,070 / 1,040	1,055	1,470 / 1,450	1,470
EER	M Models	10.8	11.0 / 11.2	11	9.5	9.5
	N Models	N / A	N / A	N / A	N / A	N / A
UNIT WITHOUT ELECTRIC HEATER						
Min. Circuit Amps ^{2, 4, 12}		5.7	6.4	5.7	8.8	7.7
CFM (Cool/Wet Coil)	High	325	235 / 230	230	325 / 315	325
	Low	250			250 / 220	250
CFM (Dry Coil)	High	345	245 / 240	240	345 / 335	345
	Low	265			265 / 235	265
Ventilated Air, CFM (Fan Only)*		70*	65*	65*	70*	70*
Ventilated Air, CFM (Compressor & Fan)*		70*	65*	65*	70*	70*
Dehumidification (Pints/Hr.)		3.5	3.5	3.5	4.4	4.4
Net Weight (lbs.)		105	105	105	110	110
Ship Weight (lbs.)		120	120	120	125	125

- Denotes M or N models

* Approximately 95 CFM with optional power vent kit. Actual vent CFM performance will vary due to application and installation conditions.

NOTES:

- 1- All 265-volt models must use an Amana® brand sub-base (PTSB4**E) or an Amana® brand hard-wire kit (PTPWHWK4).
- 2- Minimum Circuit Ampacity (MCA) ratings conform to the National Electric Code; however, local codes should apply.
- 3- Minimum voltage on 230/208-volt models is 197 volts; maximum is 253 volts. Minimum voltage on 265-volt models is 238.5 volts; maximum is 291.5 volts.
- 4- Overcurrent protection for **all units without electric heaters** is 15 amps. Overcurrent protection on 265-volt models must be cartridge-style time-delay fuses (included and factory-installed on all Amana® brand 265-volt chassis). See heater performance for total MCA.
- 5- Heating capacity and efficiency based on unit operation without condensate pump; unit automatically switches to electric heat at approximately 24°F outdoor ambient.
- 6- Total watts for 12,000 and 15,000 BTU/h models; subtract 70 watts for PT07/09*B**A*
- 7- Specify two-digit heater kW size to complete model number.
- 8- Total amps for 12,000 and 15,000 BTU/h models; subtract 0.2 amps for PT07/09*B**A*.
- 9- R-22 refrigerant used in all systems.
- 10- All units meet or exceed ASHRAE 90.1 standards.
- 11- All units less than 250 volts have a Leak Current Detector Interrupter (LCDI) power cord and meet UL 484 standards.
- 12- Refer to electric heat performance data for total MCA and recommended overcurrent protection. Amps and Watts notation refers to compressor only.

PRODUCT SPECIFICATIONS

PRODUCT SPECIFICATIONS : PTC / PTH — ELECTRIC HEAT PERFORMANCE

(Primary Heating for PTC Models; Auxiliary Heating for PTH Models; See below for Power Cord Configuration)

VOLTAGE	ELECTRIC HEATER SIZE (kW)	NO. OF STAGES	NOMINAL HEATING (BTU/h)			TOTAL WATTS ⁶	TOTAL AMPS ⁸	MINIMUM CIRCUIT AMPACITY ²	MOD ⁴ (AMPS)	POWER CORD
			@ 230V	@ 208V	@ 265V					
230/208V	2.5/2.0	1	8,500	6,800	--	2,650/2,140	11.5/10.2	14.2	15	6 - 15 P
230/208V	3.5/2.9	1	12,000	9,900	--	3,650/3,040	15.8/14.5	19.6	20	6 - 20 P
230/208V	5.0/4.1	1*	17,100	14,000	--	5,150/4,240	22.3/20.3	27.7	30	6 - 30 P
265V	2.5	1	--	--	8,500	2,650	10.0	12.4	15	7 - 20 P
265V	3.7	1	--	--	12,600	3,850	14.6	18.1	20	7 - 20 P
265V	5.0	1*	--	--	17,100	5,150	19.5	24.2	25	7 - 30 P

* PTH/PTC09*B50*G/K has the same airflow as a PTC/PTH12*B***G (not available on 7,000 BTU/h models).

NOTES:

- 1- All 265-volt models must use an Amana® brand sub-base (PTSB4**E) or an Amana® brand hard-wire kit (PTPWHWK4).
- 2- Minimum branch circuit ampacity ratings conform to the National Electric Code; however, local codes should apply.
- 3- Minimum voltage on 230/208-volt models is 197 volts; maximum is 253 volts.
Minimum voltage on 265-volt models is 238.5 volts; maximum is 291.5 volts.
- 4- Overcurrent protection for **all units without electric heaters** is 15 amps. Overcurrent protection on 265-volt models must be cartridge-style time-delay fuses (included and factory-installed on all Amana® brand 265-volt chassis).
- 5- Heating capacity and efficiency based on unit operation without condensate pump; unit automatically switches to electric heat at approximately 24°F outdoor ambient.
- 6- Total watts for 12,000 and 15,000 BTU/h models; subtract 70 watts for PT07/09*B**A*
- 7- Specify two-digit heater kW size to complete model number.
- 8- Total amps for 12,000 and 15,000 BTU/h models; subtract 0.2 amps for PT07/09*B**A*.
- 9- R-22 refrigerant used in all systems.
- 10- All units meet or exceed ASHRAE 90.1 standards.
- 11- All units less than 250 volts have a Leak Current Detector Interrupter (LCDI) power cord and meet UL 484 standards.

POWER CORD CONFIGURATION

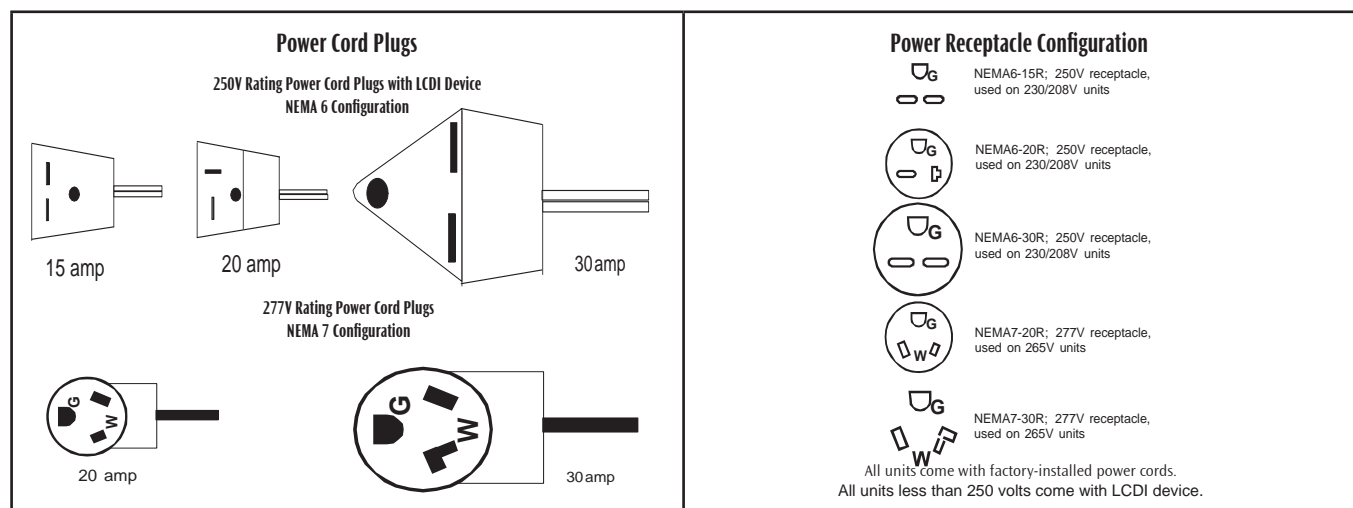

PRODUCT SPECIFICATIONS : PTH — HEAT PUMP/ELECTRIC HEAT

Model ^{1, 3, 9, 10, 12}		PTH 073B**A-	PTH 074B**A-	PTH 093B**AM	PTH 094B**AM	PTH 123B**AM
Voltage ^{1, 3, 11}		230 / 208	265	230 / 208	265	230 / 208
Capacity (BTU/h)	M Models	7,000 / 6,800	7,000	9,100 / 8,900	9,100	12,000 / 11,800
	N Models	7,400 / 7,300	7,300	N / A	N/A	N / A
Amps ¹²		2.8 / 3.0	2	3.5 / 3.8	3	4.6 / 5.0
Watts ¹²		605 / 585	605	790 / 775	790	1,110 / 1,090
EER	M Models	11.6 / 11.6	12	11.5	11.5	10.8
	N Models	12.4 / 12.8	12.4	N / A	N/A	N / A
UNIT WITHOUT ELECTRIC HEATER						
Min. Circuit Amps ^{2, 4, 12}		4	3.6	5.1	4.4	6.4
CFM (Cool/Wet Coil)	High	245 / 240	245	245 / 240	245	325 / 315
	Low	220 / 205	220	220 / 205	220	250 / 229
CFM (Dry Coil)	High	265 / 260	265	265 / 260	265	345 / 335
	Low	230 / 215	230	230 / 215	230	265 / 235
Ventilated Air, CFM (Fan Only)*		65*	65*	65*	65*	70*
Ventilated Air, CFM (Compressor & Fan)*		65*	65*	65*	65*	70*
Dehumidification (Pints/Hr.)		1.6	1.6	2.6	2.6	3.5
Net Weight (lbs.)		95	95	100	100	110
Ship Weight (lbs.)		110	110	115	115	125

Model ^{1, 7, 9, 10, 12}		PTH 124B**AM	PTH 123C**AM	PTH 124C**AM	PTH 153B**AM	PTH 154B**AM
Voltage ^{1, 3, 11}		265	230 / 208	265	230 / 208	265
Capacity (BTU/h)	M Models	12,000	11,500 / 11,200	11,300	14,000 / 13,900	14,000
	N Models	N/A	N/A	N/A	N / A	N/A
Amps ¹²		4.3	4.6 / 5.0	4	6.3 / 6.9	5.9
Watts ¹²		1,110	1,020 / 1,000	1,070	1,505 / 1,495	1,505
EER	M Models	10.8	10.6	10.6	9.3	9.3
	N Models	N/A	N/A	N/A	N / A	N/A
UNIT WITHOUT ELECTRIC HEATER						
Min. Circuit Amps ^{2, 4, 12}		5.7	6.4	5.7	8.8	7.7
CFM (Cool/Wet Coil)	High	325	235 / 230	230	325 / 315	325
	Low	250			250 / 220	250
CFM (Dry Coil)	High	345	245 / 240	240	345 / 335	345
	Low	265			265 / 235	265
Ventilated Air, CFM (Fan Only)*		70*	65*	65*	70*	70*
Ventilated Air, CFM (Compressor & Fan)*		70*	65*	65*	70*	70*
Dehumidification (Pints/Hr.)		3.5	3.5	3.5	4.4	4.4
Net Weight (lbs.)		110	110	110	115	115
Ship Weight (lbs.)		125	125	125	130	130

- Denotes M or N models

* Approximately 95 CFM with optional power vent kit; actual vent CFM performance will vary due to application and installation conditions.

** EER = Energy Efficiency Rating per Air Conditioning & Refrigeration Institute (ARI) and Canadian Standards Association (CSA) EEV Test Procedures.

Notes:

- 1- All 265-volt models must use an Amana® brand sub-base (PTSB4**E) or an Amana® brand hard-wire kit (PTPWHWK4).
- 2- Minimum Circuit Ampacity (MCA) ratings conform to the National Electric Code; however, local codes should apply.
- 3- Minimum voltage on 230/208-volt models is 197 volts; maximum is 253 volts. Minimum voltage on 265-volt models is 238.5 volts; maximum is 291.5 volts.
- 4- Overcurrent protection for **all units without electric heaters** is 15 amps. Overcurrent protection on 265-volt models must be cartridge-style time-delay fuses (included and factory-installed on all Amana® brand 265-volt chassis). See heater performance for total MCA.
- 5- Heating capacity and efficiency based on unit operation without condensate pump; unit automatically switches to electric heat at approximately 24°F outdoor ambient.
- 6- Total watts for 12,000 and 15,000 BTU/h models; subtract 70 watts for PT07/09*B**A*
- 7- Specify two-digit heater kW size to complete model number.
- 8- Total amps for 12,000 and 15,000 BTU/h models; subtract 0.2 amps for PT07/09*B**A*.
- 9- R-22 refrigerant used in all systems.
- 10- All units meet or exceed ASHRAE 90.1 standards.
- 11- All units less than 250 volts have a Leak Current Detector Interrupter (LCDI) power cord and meet UL 484 standards.
- 12- Refer to electric heat performance data for total MCA and recommended overcurrent protection. Amps and Watts notation refers to compressor only.

PRODUCT SPECIFICATIONS

PRODUCT SPECIFICATIONS (CONT.) : PTH — REVERSE-CYCLE HEATING PERFORMANCE

HEATING CAPACITY ¹		PTH 073B** A-	PTH 074B** A-	PTH 093B** AM	PTH 094B** AM	PTH 123B** AM
BTU/h ⁵	M Models	6,200 / 6,000	6,200	8,200 / 8,000	8,200	10,800 / 10,600
	N Models	6,400 / 6,300	6,200	---	---	---
Amps ¹²		2.6 / 3.0	2.2	3.2 / 3.6	2.6	4.5 / 5.1
Watts ¹²		550 / 530	550	750 / 730	750	1,020 / 1,000
COP ⁵	M Models	3.3 / 3.3	3.3	3.2	3.2	3.1
	N Models	3.5 / 3.6	3.5	---	---	---
CFM (Dry)		265/260	265	265/260	265	345/335
Heating	62 °F	7,200 / 7,000	7,200	9,800 / 9,600	9,800	13,000 / 12,800
(BTU/h) ⁵ @	57 °F	6,900 / 6,700	6,900	9,300 / 9,100	9,300	12,300 / 12,100
Outdoor	52 °F	6,500 / 6,300	6,500	8,700 / 8,500	8,700	11,600 / 11,400
Ambient	47 °F	6,200 / 6,000	6,200	8,200 / 8,000	8,200	10,800 / 10,600
Rating Point	COP*	3.3 / 3.3	3.3	3.2 / 3.2	3.2	3.1 / 3.1
	42 °F	5,900 / 5,700	5,900	7,700 / 7,500	7,700	10,100 / 9,900
	37 °F	5,600 / 5,400	5,500	7,200 / 7,000	7,200	9,400 / 9,200
	32 °F	5,300 / 5,100	5,200	6,700 / 6,500	6,700	8,600 / 8,400
	27 °F	5,000 / 4,800	5,000	6,200 / 6,000	6,200	7,900 / 7,700
	24 °F	4,800 / 4,600	4,800	5,900 / 5,700	5,900	7,500 / 7,300
Watts @	62 °F	580 / 560	580	810 / 790	810	1,120 / 1,100
Outdoor	57 °F	575 / 555	575	800 / 780	800	1,090 / 1,075
Ambient	52 °F	555 / 535	555	775 / 755	775	1,060 / 1,045
	47 °F	550 / 530	550	750 / 730	750	1,020 / 1,005
	42 °F	540 / 525	560	730 / 710	730	985 / 970
	37 °F	530 / 515	545	705 / 685	705	950 / 935
	32 °F	515 / 500	535	690 / 670	690	900 / 885
	27 °F	505 / 490	525	660 / 640	660	855 / 840
	24 °F	500 / 485	520	640 / 620	640	830 / 815

HEATING CAPACITY ¹		PTH 124B** AM	PTH 123C** AM	PTH 124C** AM	PTH 153B** AM	PTH 154B** AM
BTU/h ⁵	M Models	10,800	10,000 / 9,500	10,000	13,300 / 13,200	13,300
	N Models	---	---	---	---	---
Amps ¹²		3.9	4.5 / 5.1	3.9	5.7 / 6.3	5.4
Watts ¹²		1,020	1,020 / 1,000	1,020	1,340 / 1,330	1,340
COP ⁵	M Models	3.1	2.9	2.9	2.9	2.9
	N Models	---	---	---	---	---
CFM (Dry)		345	245/240	240	345 / 335	345
Heating	62 °F	13,000	12,200 / 11,700	12,200	15,800 / 15,700	15,800
(BTU/h) ⁵ @	57 °F	12,300	11,500 / 11,000	11,500	15,000 / 14,900	15,000
Outdoor	52 °F	11,600	10,800 / 10,300	10,800	14,200 / 14,100	14,200
Ambient	47 °F	10,800	10,000 / 9,500	10,000	13,300 / 13,200	13,300
Rating Point	COP*	3.1	2.9 / 2.9	2.9	2.9 / 2.9	2.9
	42 °F	10,100	9,300 / 8,800	9,300	12,500 / 12,400	12,500
	37 °F	9,400	8,600 / 8,100	8,600	11,700 / 11,600	11,700
	32 °F	8,600	7,800 / 7,300	7,800	10,800 / 10,700	10,800
	27 °F	7,900	7,100 / 6,600	7,100	10,000 / 9,900	10,000
	24 °F	7,500	6,700 / 6,200	6,700	9,500 / 9,400	9,500
Watts @	62 °F	1,120	1,120 / 1,100	1,120	1,465 / 1,455	1,465
Outdoor	57 °F	1,090	1,090 / 1,075	1,090	1,440 / 1,430	1,440
Ambient	52 °F	1,060	1,060 / 1,040	1,060	1,405 / 1,395	1,405
	47 °F	1,020	1,020 / 1,000	1,020	1,340 / 1,330	1,340
	42 °F	985	985 / 965	985	1,325 / 1,315	1,325
	37 °F	950	950 / 935	950	1,285 / 1,275	1,285
	32 °F	900	900 / 885	900	1,240 / 1,230	1,240
	27 °F	855	855 / 840	855	1,190 / 1,180	1,190
	24 °F	830	830 / 815	830	1,180 / 1,170	1,180

See Page 9 for Notes and Auxiliary Electric Heater Performance.

CONTRACT BID SPECIFICATIONS

Ratings

Each unit must meet the following specifications:

ARI rating of _____ BTU/h cooling (and _____ BTU/h reverse cycle heating with a COP of _____ at 47° F O.D.)

Electric resistance heat of _____ BTU/h. Total Amp draw must be of _____ and _____ Watts at _____ volts.

The unit must remove a minimum of _____ pints of moisture per hour when operated at rating conditions. The EER must be a minimum of _____ EER.

Unit Chassis

Each unit must be of slide-out design shipped with room cabinet front-installed. Unit chassis must have the ability to be installed with 0 clearance from finished floor. An electrical power cord must be included with chassis and installed by the manufacturer to assure proper NEMA 6 or 7 configuration and UL-approved length. Units less than 250 volts must also have a LCDI power cord. Unit must be tested for conformance to ASTM water infiltration specification ASTM 331-86, which ensures no water infiltration when tested at 8" rain per hour at 63 mph wind for 15 minutes.

Room Cabinet

The monochromatic front of the room cabinet must be able to be field-secured to chassis to inhibit tampering. Filter must be accessible without removing room front. Cabinet depth must not exceed 7³/₈" to minimize unit's impact on room space.

Coils

Unit coils must have rifled copper tubing expanded into rippled-edge louvered aluminum fins. Exterior coil must be of a two-row bent coil design with removable shroud top to allow easy-access for cleaning of the exterior coil.

Heat Pumps

Each unit must include a change-over thermistor that senses an outside ambient switch-over temperature as low as 24°F, lock-open refrigerant reversing valve during heat pump operation, temperature-activated defrost drain, and automatic emergency heat operation to override the heat pump's change-over thermostat and bring on electric resistance heaters in the event of a sealed system failure. Unit must not operate compressor and electric heaters simultaneously.

Compressor

The compressor must be hermetically sealed, internally isolated, rotary-type, and permanently mounted on rubber isolators. No removal or adjustment of compressor hold-down bolts is to be required during installation.

Warranty

The warranty is for Full One Year on the entire unit; Full Second through Fifth Year on the entire sealed refrigerant system components; Limited Second through Fifth Year on functional parts only.

Unit Digital Controls

Unit control must be completely wired and accessible from the top of the chassis. Controls shall be an LED touch-pad design with six large, easy-to-read and use buttons: Heat – Cool – Off – Fan – Temp+ (plus) – Temp- (minus) and two red seven-segment LED temperature displays. Unit shall have a green status LED to advise owner of dirty filter, dirty coil, or operational diagnostic messages. Unit shall have one-button activation via membrane touch-pad. Unit control board shall have an 18-pin low-voltage connector to allow for easy connection to remote wired devices. Unit shall have two serial-port connectors for easy connection to wired or future wireless EMS (Energy Management Systems).

Unit must have the ability to easily configure owner-selectable and programmable functions:

- • Fan-cycle operation
- • Electronic temperature limiting for cooling
- • Electronic temperature limiting for heating
- • Enhanced dehumidification cooling operation
- • Temperature set-back when inactive
- • Un-rented temperature set-back
- • Load-shedding operation
- • Front-desk on-off or temperature set-back

Unit must have the ability to connect to approved remote devices:

- Wireless or wired thermostat
- Wireless or wired door switch
- Wireless or wired room occupancy sensor
- Wireless or wired room-to-room transfer fan
- Front Desk Control
- RF wireless communications devices

Unit must be able to acquire and display operational temperature data from up to six installed thermistors to include:

- IAT—Indoor air temperature (black)
- ICT—Indoor coil temperature (red)
- IDT—Indoor discharge temperature (yellow)
- OCT—Outdoor coil temperature (blue) (heat pumps)
- Green—Miscellaneous temperature (ex. Outdoor ambient) (optional)
- Orange—Miscellaneous thermistor or analog device (optional)

Evaporator/Condenser Fans

Direct drive with a permanent, split-capacitor, two-speed motor. Condensate must be directed onto the back and sides of the bent coil to aid in evaporation and removal.

Air Discharge

Must be a sloped surface so that obstructions cannot be placed on the unit. Discharge conditioned air can be directed into the room at an angle of 15 or 40 degrees from the vertical position. The discharge grille must be of polycarbonate material to resist bending, cracking, rusting and corrosion.

PRODUCT SPECIFICATIONS

NEW INSTALLATIONS TYPICALLY REQUIRE A MINIMUM OF **WS900D** WALL SLEEVE AND AN OUTDOOR GRILLE.

Wall Sleeves (WS900D)

The wall sleeve must be industry-accepted dimensions: 14¹/₈" depth x 42" width x 16¹/₁₆" height and constructed of G90 HDG galvanized steel with a baked corrosion-inhibiting urethane primer and baked-polyester topcoat enamel. Sleeve must be insulated and shipped with a weather resistant rear closure panel installed.

Outdoor Grilles

Outdoor grille must be architecturally extruded, louvered aluminum (AGK01*B), one-piece polymer-blend injection molded louver (PGK01*B) or standard stamped aluminum (SGK**B). All other grilles must be submitted to the PTAC manufacturer for feasibility, airflow characteristics and compliance with UL regulations, where necessary.

THE OPTIONAL ACCESSORIES LISTED BELOW PERFORM SPECIFIC FUNCTIONS REQUIRED IN SOME INSTALLATIONS.

Condensate Drain Kit (DK900D)

Attaches to the bottom of the wall sleeve for directional-controlled internal or external disposal of condensate, defrost or rain water.

Sub-base Kit (PTSB***E)

Necessary for UL listing requirements for 265V units (Hard Wire Kit may be substituted for Sub-base kit). Optional for 230/208V units. Must be pre-wired to facilitate field-electrical connections and include a NEMA 6 or 7 configuration electrical receptacle. It must have 2 leveling screws for sleeve support and accurate unit leveling during installation. Locations for field installation of physical disconnect switches, cartridge-style fuse holders and circuit breakers must be provided. Side-skirts must be provided with sub-bases. (PTSB000E Non-Electrical Sub-base available.)

Power Vent & Damper

Must be provided to maximize ventilation air intake to up to approximately 95 CFM. Power vent must be off and damper door closed when unit fan is de-energized.

Fuse Holder (included in 265V chassis)

Must be installed either in the unit or the sub-base and must match the electrical requirements of the chassis.

Security Key Locks (KL03B)

Must be installed to prevent tampering of the unit controls. Unit room cabinet must also be secured to the chassis with field supplied screws. UL-approved for institutional use only.

Disconnect Switch

Power disconnect switch must be installed in sub-base for use as a physical disconnect, where required by local codes.

Duct Kits (MDK02B, EDK02B, TDK02)

Three kits must be supplied to provide ducted, conditioned air into a second room: a main duct kit, an extension duct kit and a terminal duct kit.

Hydronic Heat Kit

Required for heating functions instead of electric resistance heaters. Unit must retain complete service access with the kit installed. Proper water or steam valves must be used.

Condensate Removal Pump (Heat Pumps only)

Must be installed to assist in removing the condensate developed by the heat pump operation and transfer it to the indoor coil to dissipate into the room, adding humidity to the room.

Circuit Breaker Kit

Must be installed in sub-base to provide overcurrent protection for proper 230/208V amperage. Can also be used as a physical disconnect where local codes permit for 230/208 voltage.

Hard Wire Kit

Must be used to permanently wire chassis for hard wire purposes. (For 265V units, Hard Wire Kit may be substituted with Sub-base Kit.)

Charcoal Filter Kit -- Optional (CFK10B)

Amana® brand Activated Charcoal filters absorb odors caused by cigarette, pipe or cigar smoke and airborne odors caused by mold, mildew, etc. These replacement filters are polyester fibers coated with activated charcoal. Each filter is individually wrapped to assure maximum absorption and durability when installed. (10 filters per kit.)

Thermostats

A manufacturer-approved wired thermostat (manual, auto changeover or programmable) may be installed to set the desired room temperature. A Remote Escutcheon Kit must be used to indicate remote operation.

INSTALLATION: UNIT WITH ACCESSORY WALL SLEEVE AND SUB-BASE ACCESSORY

TOP VIEW

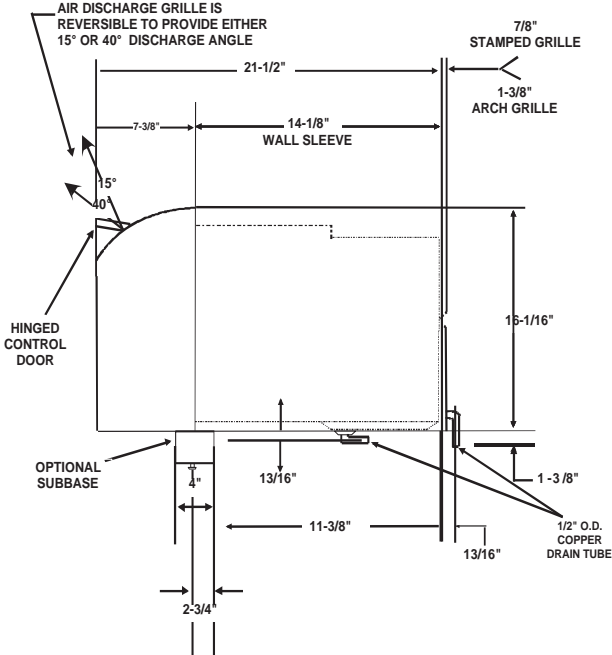
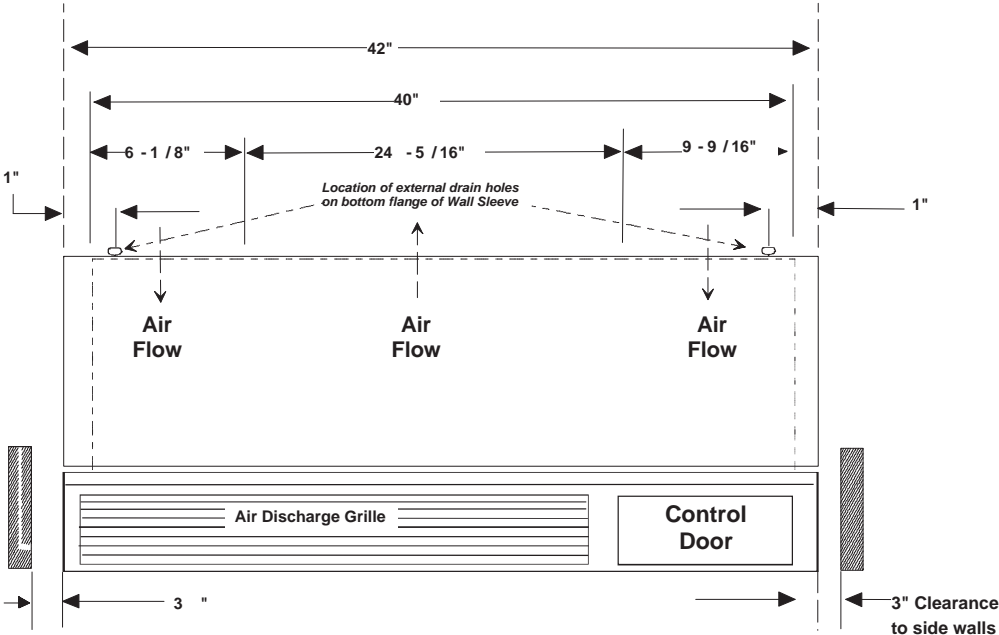

FRONT VIEW

58" LCDI CORD SET 230V/208V UNIT*
 18" CORD SET 265V UNIT*

RIGHT VIEW

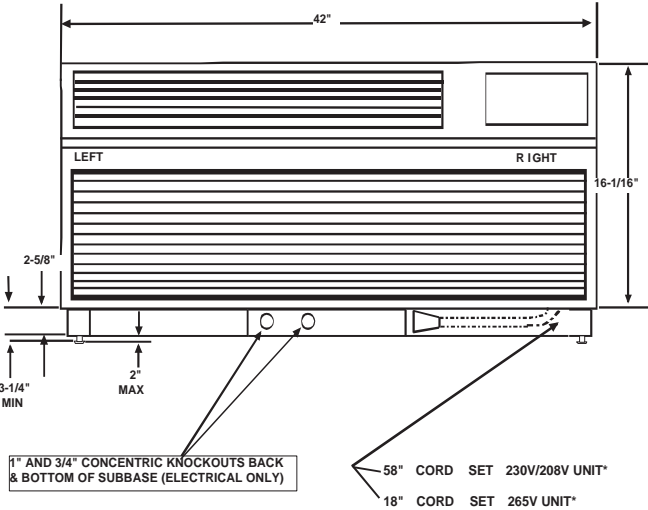

FRAMING FOR ACCESSORY WALL SLEEVE (WS900D)

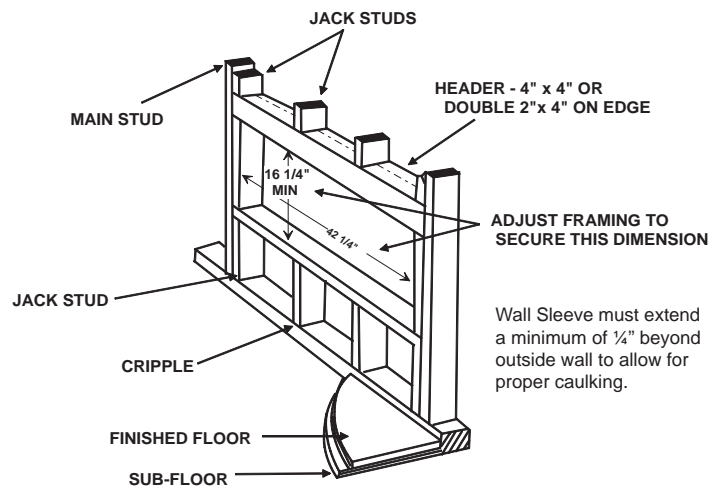
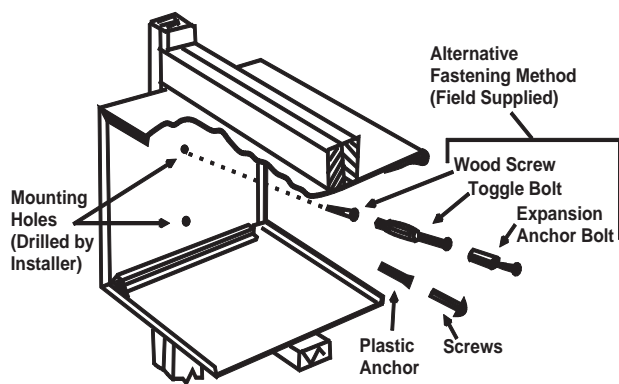

FASTENING WALL SLEEVE

When installed in an opening, the Wall Sleeve must be horizontally level (side-to-side) and pitched 1/4 bubble to the outside. (NOTE: To ensure unit's maximum efficiency, DO NOT over- or under-pitch.)

Wall Sleeve Opening Height should be squared with	H = 16 1/4"
Wall Sleeve Opening Width	W = 42 1/4"

INSTALLATION NOTES

1. If Sub-base (PTSB***E) is installed, allow minimum 3 1/4" height clearance and maximum 5" height clearance between wall sleeve and floor; allow minimum 2 3/4" protrusion from a finished wall. See Note 4 if using hydronic units.
2. Drain Kit (DK900D) shipped separately. Can be mounted either right side, left side, or bottom of sleeve. If mounted to bottom of sleeve, allow 2" height clearance from floor to bottom of sleeve.
3. For UL approval, 265V units must use Amana® brand Sub-base (PTSB***E) or Amana® brand Hard-Wire Kit (PTPWHWK4). Overcurrent protection on 265V units must be by cartridge-style time-delay fuses, which are included and factory-installed on the Amana® brand 265V chassis.
4. If Hydronic Kit (HWK03B or HVK03B) is installed, Wall Sleeve must extend exactly 3" into the room from the finished interior wall. If using the Amana® brand Sub-base (PTSB***E), only the minimum 3 1/4" height clearance between wall sleeve and floor is permissible. Unit must also be operated with a remote-mounted thermostat.
5. If Duct Kit (MDK02B) is installed, allow a minimum of 2 3/8" into the room from the finished interior wall.



Amana® is a trademark of Maytag Corporation and used under license to Goodman Company, L.P. All rights reserved. Our continuing commitment to quality products may mean a change in specifications without notice.

Copyright © 2008 • Goodman Company, L.P. • Houston, Texas • Printed in the USA.